

Messenger cable suspension insulated, rotatable, reinforced, to pipe D = 70 mm, cable Ø max. 21 mm

Item number D2559-03

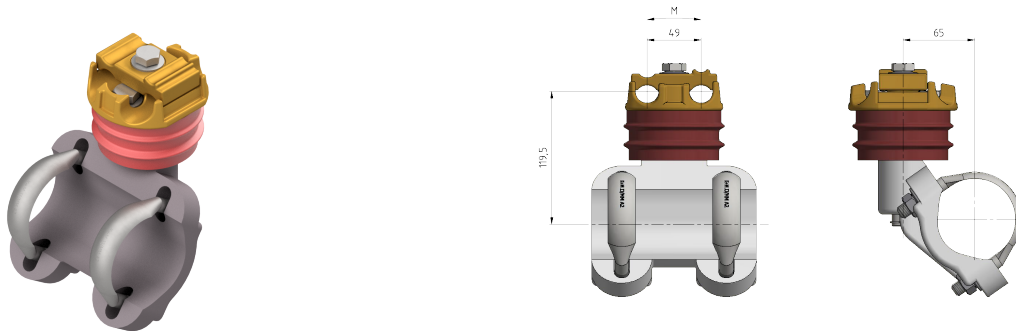

Material and weight

Material: Al/SST/Synth.

Loads

Breaking moment M: 1680 Nm

Specification

Operating voltage: max. 1500 V DC, max. 1000 V AC

Comments

- The installation side of the messenger cable has to be selected so that the lateral force cause by the curve pull act in direction of the cap screw
- For cable diameter
- Ø= 10-16 mm and 21 mm
- Use for other cable diameter on request
- Additional messenger cable suspensions for 3000 V DC on request