

# Pipe attachment complete with U-bolt round, to pipe $\varnothing = 90$ mm

Item number D2336-14

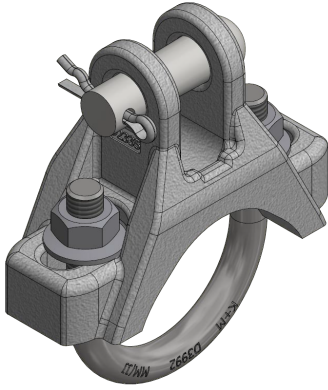

## Dimensions

B: 70 mm  
A: 20 mm  
 $\varnothing 1$ : 16 mm  
 $\varnothing 2$ : M12

## Material and weight

Material: Al/SST

## Loads

Breaking load FL along: of clevis fork 14.0 kN  
Breaking load FQ across: of clevis fork 4.5 kN  
Breaking load FZ on traction: 30.0 kN

## Comments

- Additional executions on request