

Switch cabinets, with 3 knives blades, 3 entries/3 exits

Item number 101450

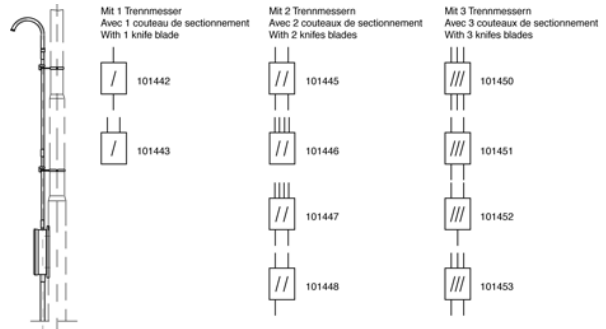
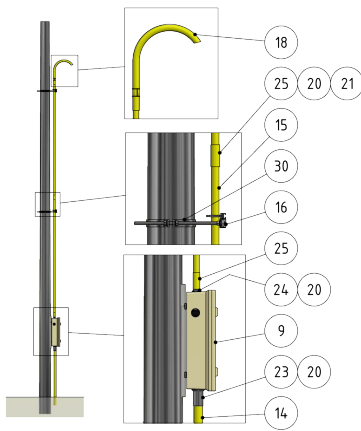

Comments

- Attachment to round pole

- Clamp for round pole, part no. C1139-... (to be ordered separately)