

Line insulator to pipe 45 mm KUSYS type 2 with double suspension eye

Item number C2376-04

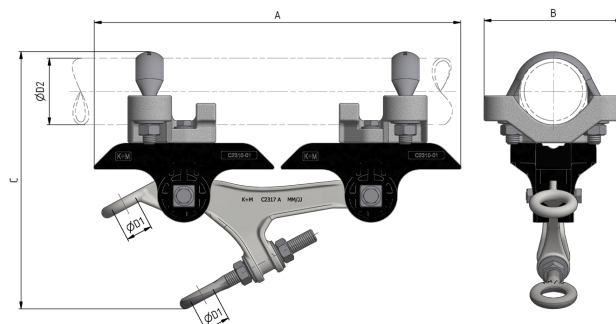

Dimensions

A: 334 mm
B: 100 mm
C: 222 mm
ØD1: 24 mm
ØD2: 45 mm

Material and weight

Material: Kst / INOX / Alu
Weight: 2.85 kg

Loads

Breaking load horizontal: 27 kN
Tightening torque for bolts and hex-nuts M8: 17 Nm
Tightening torque for bolts M12: 40 Nm

Applicable standards

DIN EN 50119
DIN EN 50124-1

DIN EN 50151
CEI / IEC 60060-1

Function

Insulator body for fastening to pipes, in medium to narrow bends. Continuously adjustable double suspension eye allowing the attachment of all type curve rail.

Specifications

Operating voltage: max. 1500 V DC

Comments

The application in overhead contact lines requires a wide insulation of the support structure to the support bases.
Optional: Exchanging the u-bolt allows mounting to pipes Ø45 - 80mmmm.
The suspension can be mounted to cross-spans or ceilings by exchanging the clamp.