

**Contact wire suspension ETB rigid, without insulation, in tangent,
to cross-span of synthetic material $\varnothing = 13.5$ mm, 0° , with contact
wire clamp 5/8"**

Item number 101546

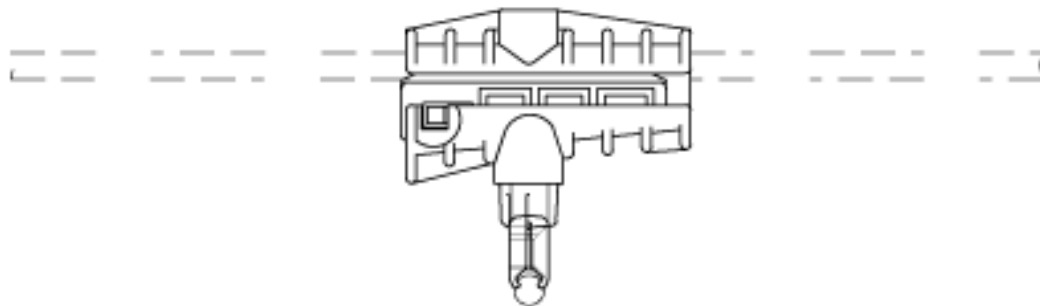

Comments

- Contact wire clamp CuAl
- Clamp short STL HGD